

Part No:  
BB1270



latest instructions



TEMP1



Temperature sensor  
included

# STERLING POWER

## Sterling Power Products 12V to 12V 70A Battery to Battery Charger Handbook

### BB1270

EURO 6



UK  
CA



RoHS  
compliant



[www.sterling-power.com](http://www.sterling-power.com)  
[www.sterling-power-usa.com](http://www.sterling-power-usa.com)

**Warranty (2 years return to factory)**

Copyright © 2022  
Sterling Power  
All Rights Reserved

E MARKING  
E24 10R06/01 3789 00

**INTRODUCTION TABLE OF CONTENTS**

**Introduction**  
 02 Table of Contents | Dimension Drawing  
 03 Welcome

**Safety and Legal**  
 04 Legal Guidelines / Warranty Statement  
 05 Safety Guidelines

**Product Information**  
 06 Basic Wiring Diagram / Installation Orientation  
 07 Annotated diagram of front section of BB1270  
 08 Annotated diagram of connector panel  
 09 Front digital display functions  
 10 3 type of product activation

**Troubleshooting**  
 11 Troubleshooting and fault finding  
 12 Troubleshooting and fault finding

Dimensions drawing  
(not to scale)



Dimensions  
Weight

200mm x 130mm x 56mm  
1.0Kg



**INTRODUCTION WELCOME**

**Welcome** Welcome to the Sterling Power Products Owners Handbook for the product BB1270, the 12V to 12V battery to battery charger (70A input rated).

Please take your time to read and fully understand the contents of this Handbook. These guidelines are developed with your safety and the products performance in mind and failure to follow or understand these guidelines may lead to voiding the product warranty or even leading to damage or injury for you or your setup.

If you are unsure of any step or guideline then please consider reaching out to Sterling via our web contact form or our phone service and we shall offer our support.

Thank you for joining the Sterling family and we hope to serve your travels well.

**12V - 12V  
70A** This 12V to 12V battery to battery charger is a device typically installed between a starter battery (input) and a house / domestic / service battery (output). The BB1270 is designed to charge up your 12V domestic / service / auxiliary battery from the power generated from your alternator, whilst your engine is running. It is designed to work with vehicles (old / new) and (boats old / new). As this device is 70A rated on the input, we recommend running from an alternator 90A+. This BB charges both lead acid style batteries and lithium batteries.

Throughout this manual we will make reference to this product as the 'BB'. The term '12V' is the nominal voltage, not the specific voltage.

**Using this Handbook** This manual must be read throughout before installing this electronic device. Do not lose these instructions - keep them safe. The most up to date instructions can be found on sterling-power.com. Please refer to the latest instruction manual before contacting Sterling. At Sterling, we endeavour to include all of the product information that we can think of into the manual.

Installation of the electronic device must be carried out by qualified and trained personnel only. The personnel must be familiar with the locally accepted guidelines and safety measures.

**Safety** Your safety is Sterling's top priority. Please follow all precautions to keep yourself safe. If you believe your unit requires repair then please contact Sterling or your distributor. Do not attempt to service the unit yourself.

<b>Specifications</b>	<b>BB1270</b>	
	Input voltage range	9V-16V
	Rated output power	60A at 13.8V
	Rated input current	70A
	Quiescent current	10mA
	Efficiency rating	92%-94%
	Self recovering protections:	under voltage protection input over voltage protection output over voltage protection over current protection charge over temperature
	Operational Temperature	-20 Deg C -> 60 DegC
	Approval	CE   UKCA E-Marking
	Cooling method	Thermostatically Controlled Variable low speed fan
	Dimensions	200mm x 130mm x 56mm
	Weight	1.0Kg



## SAFETY AND LEGAL LEGAL GUIDELINES

---

### Warranty and Terms

Your 100 % satisfaction is our goal. We realise that every customer and circumstance is unique. If you have a problem, question, or comment please do not hesitate to contact us. We welcome you to contact us even after the warranty and return time has passed.

Each product manufactured by Sterling Power comes with at least a 2 year limited factory warranty. Certain Products have a warranty period of time greater than 2 years. Each product is guaranteed against defects in material or workmanship from the date of purchase. At our discretion, we will repair or replace free of charge any defects in material or workmanship that fall within the warranty period of the Sterling Power product. The following conditions do apply:

- The original receipt or proof of purchase must be submitted to claim warranty. If proof cannot be located a warranty is calculated from the date of manufacture.
- Our warranty covers manufacture and material defects. Damages caused by abuse, neglect, accident, alterations and improper use are not covered under our warranty.
- Warranty is null and void if damage occurs due to negligent repairs.
- Customer is responsible for inbound shipping costs of the product to Sterling Power either in the USA or England.
- Sterling Power will ship the repaired or warranty replacement product back to the purchaser at their cost.

If your order was damaged in transit or arrives with an error, please contact us ASAP so we may take care of the matter promptly and at no expense to you. This only applies for shipping which was undertaken by our company and does not apply for shipping organised by yourself. Please do not throw out any shipping or packaging materials. All returns for any reason will require a proof of purchase with the purchase date. The proof of purchase must be sent with the returned shipment. If you have no proof of purchase call the vendor who supplied you and acquire the appropriate documentation.

To make a claim under warranty, call our customer care check telephone numbers on [www.sterling-power.com](http://www.sterling-power.com) or [www.sterling-power-usa.com](http://www.sterling-power-usa.com). We will make the best effort to repair or replace the product, if found to be defective within the terms of the warranty. Sterling Power will ship the repaired or warranty replacement product back to the purchaser, if purchased from us.

Please review the documentation included with your purchase. Our warranty only covers orders purchased from Sterling Power. We cannot accept warranty claims from any other Sterling Power distributor. Purchase or other acceptance of the product shall be on the condition and agreement that Sterling Power USA LLC and Sterling Power LTD shall not be liable for incidental or consequential damages of any kind. Some states may not allow the exclusion or limitation of consequential damages, so, the above limitations may not apply to you. Additionally, Sterling Power USA and Sterling Power LTD neither assumes nor authorizes any person for any obligation or liability in connection with the sale of this product. This warranty is made in lieu of all other obligations or liabilities. This warranty provides you specific legal rights and you may also have other rights, which vary from state to state. This warranty is in lieu of all other, expressed or implied.

### Copyright and Plagiarism

Copyright © 2021 Sterling Power. All rights reserved. Reproduction, transfer, distribution or storage of part or all of the contents of this document is strictly prohibited. If you wish to use all of this document, or excerpts from it, Sterling Power must be contacted.

### Liability

Sterling Power can not accept liability for:

- consequential damage due to use of this device
- possible errors in the manuals and the results thereof

### Device Modification

Please do not modify the device unless you have been instructed to do so by Sterling Power directly. Product modification shall be done at Sterling when needed. Warranty shall be voided if personal attempts are made to modify the device without Sterling's approval.



STERLING  
POWER

## SAFETY AND LEGAL SAFETY GUIDELINES

---

**Product Guidelines** Your Sterling Power product should only be utilised for its designated purpose. Use the Battery to Battery Charger ONLY :

- For DC to DC power conversion
- With fuses protecting both the input and output DC cables
- In a well ventilated, dry, dust-free and condensation free environment
- When the Owners Handbook has been read and wholly understood

**Transport and Storage** Ensure that the mains supply and battery leads are disconnected before transporting or moving the unit. No liability can be accepted for damage in transit once equipment has been unpackaged. Store the product in a dry environment, between  $-20^{\circ}\text{C}$  to  $60^{\circ}\text{C}$ .

Refer to the battery manufacturer's manual for information on transportation, stowage, charge rates, recharging and battery disposal for your battery care.

**General Maintenance** The device must be switched off during maintenance and all cables removed from the direct feed to or from the unit. It must also be protected against unexpected switching off. Remove battery connections and ensure unit is off. If repair is required, only use original parts. Unauthorised attempts to repair Sterling units will lead to the warranty being voided. Only someone with adequate understanding of electronics and the unit itself should attempt a repair.

Ensure your connections are good and clean and aim to protect your unit from humidity and water ingress.

**Safety Precautions** Electrical appliances can be heavy. Please do not lift heavy units unassisted. Ensure that your product is correct for your intent. 12V battery. Incorrect use can lead to damage. Orientation is not critical to unit function, however may affect water ingress rating. Install device in a well ventilated space for cooling purposes. Do not expose the unit to snow, rain, water, spray, condensation, pollution etc, unless it is a waterproof unit. If it is a waterproof unit, only expose it to situations it is correctly rated for. Do not cover or obstruct the ventilation. Device connects to common negative. Common negatives must be earthed. In case of fire, use fire extinguisher equipment suitable for electrical fires. Avoid all possibilities of reverse polarity or short circuiting. Check cabling and connections frequently and ensure the connections are sufficient. Always protect DC cabling with the appropriate fusing. Ensure the unit is adequately and safely mounted to prevent displacement and damage. Always use a professional to install electrical products. Ensure the product is correctly set up for your battery. Keep out of reach of children

**WARNING :** **CROSS VOLTAGE THRESHOLD BATTERY TO BATTERY CHARGERS MUST BE INSTALLED WITH CARE** A COMMON NEGATIVE IS PARAMOUNT TO OPERATION, HOWEVER, BE INCREDIBLY CAREFUL NOT TO SHORT CIRCUIT OR REVERSE POLARITY **ANY EQUIPMENT OR CABLE.**

All electrical appliances carry the risk of electrical shock. This equipment is designed to be used in combination with a permanent energy source (the battery). Always isolate the DC before performing any maintenance or inspection.

Do NOT remove the panelling to inspect the internals unless expressly told to by Sterling. This is not a product designed to be user-serviced.

Do NOT use the device in situations where there is danger of gas / dust / vapour explosions, or around potentially flammable produce.



**PRODUCT INFORMATION SIMPLE WIRING DIAGRAM**

**Basic installation diagram**

Here, we hope to provide a very basic installation diagram for the vast majority of installers to follow.

If a process is not mentioned here, the chances are that it is not a pre-requisite to get the BB1270 to function.

The default charging profile is a standard sealed lead acid charging profile of 14.4V and 13.3V float.

If you wish to charge a lithium battery, please refer to page 9 to change the charging profile.

12V ignition signal, required for Euro 6 / Smart alternator use.

Ignition gives a binary on / off style signal to control the BB1270.

If ignition signal is not used, the BB needs to see 13.5V on the input terminal to begin charging the output battery. When the input then drops below 12.8V the BB will stop charging.

**Recommended installation orientation**

The BB1270 can be mounted in any orientation. However, if the area is prone to getting wet or damp, we recommend the first or second install.

\*Label rendered for clarity,

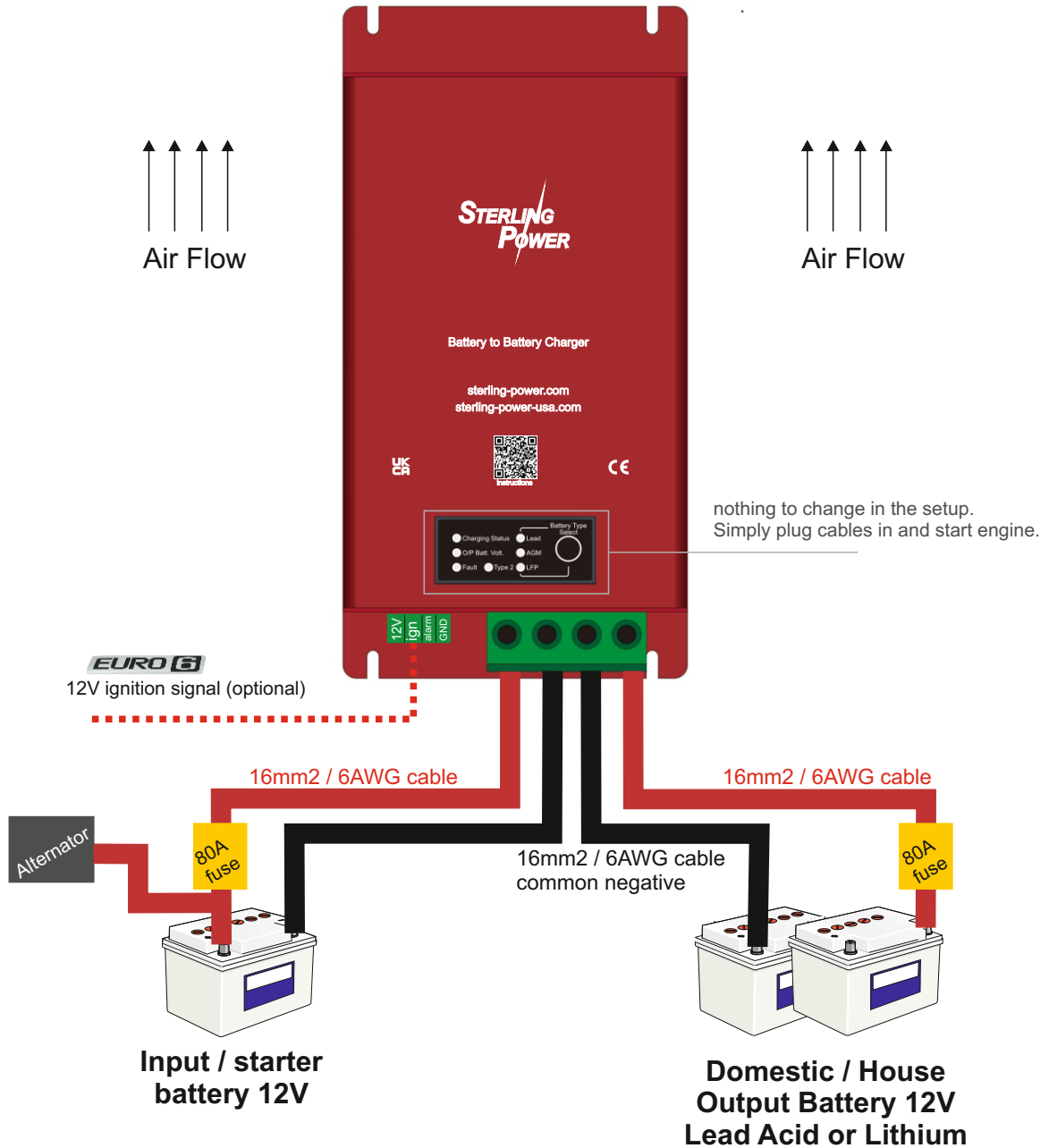

nothing to change in the setup. Simply plug cables in and start engine.

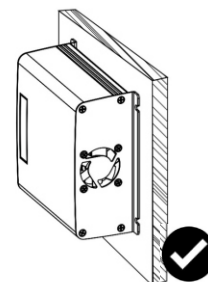
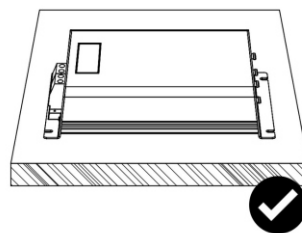
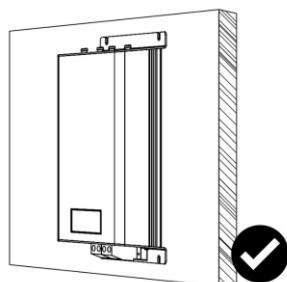

If prone to getting wet, this mounting option may result in pooling of water at the bottom

BB1270 Diagram

\*Label rendered for clarity,



1. The top mounting plate. Composed of 2x 5mm wide mounting feet. There are 2x 5mm wide mounting feet at the bottom, too.
2. Location of 2x heat extracting fans. The air is sucked through the BB and the direction of air flow is demonstrated above.
3. Display panel. More information on page 9.
4. Connection blocks. This region is described in more detail overleaf. This is the area where all the physical installation connections to the BB1270 are made. Also, this region contains additional 2x 5mm mounting feet.

BB1270 Diagram

\*Label rendered for clarity,

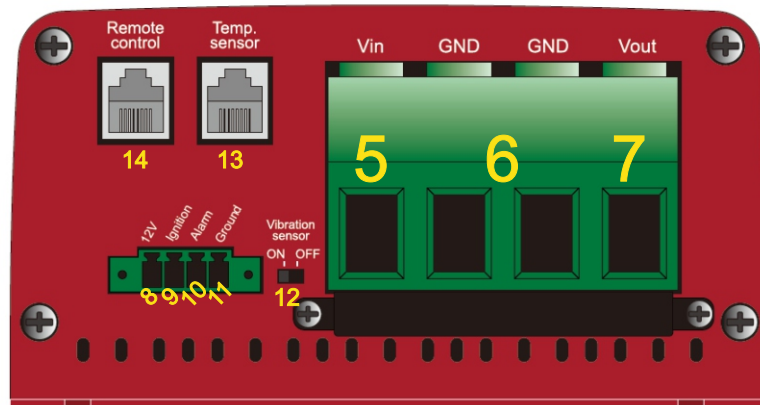

5. The left large green connector is for direct connection to the input / starter battery. 12V input connection. Ensure the cable thickness is 16mm<sup>2</sup> / 6AWG. Ensure this cable is fused at ~80A fuse.
6. These 2 central connectors are for common negative cable. For convenience, use the left GND to connect to the input battery's negative and use the right GND connector to connect to the output battery's negative. Use similar sized cable as positive.
7. The right large green connector is for direct connection to the output / leisure battery. 12V output connection. Ensure the cable thickness is 16mm<sup>2</sup> / 6AWG. Ensure this cable is fused at ~80A fuse.
8. This 12V output provides a 12V signal at 50mA. This can be used to trigger an operation / provide a 12V signal. This 12V signal shall only become live if the Ground connector (11) is connected to the common negative rail.
9. Ignition feed connector. The BB1270 can be operated based on an ignition signal - this is recommended if you have a smart alternator (Euro 6 engine). Wire a feed from your ignition into this terminal. Ensure that this feed is ~12V when the ignition is live and goes to 0V when ignition is turned off. Once the BB1270 receives its first successful ignition signal it shall render the unit dependent on an ignition signal going forward. Therefore, the BB shall not operate based purely on input voltage coming from the input battery but based on whether your ignition is live or not. You can reset this feature by removing the ignition feed and pressing / holding the front button down for 15 seconds and letting go.
10. Alarm. If the BB faults - this alarm connector shall put out a live 12V | 100mA. Therefore, you can wire in an audible 12V alarm or a 12V light / LED to convey a fault. These are optional fits. You can also use this connector to relay a 12V signal to another device to prompt an action if the BB were to fault. Ground connector (11) must be connected to the common negative rail for this alarm output to operate. More information on page 11.
11. Ground. To utilise connectors 8 or 10, a ground / negative (0V) feed needs to be connected here. For the ignition feed connector to operate, a negative feed is **NOT** required.
12. Vibration sensor on / off switch. Default off. If turned on, the BB1270 shall begin charging when the vibration sensor detects 2x vibration events. This shall override the ignition signal and allow you to install the BB without the need to install an ignition signal. This is also an operational method if you have a smart alternator / Euro 6 engine (or younger). This mode comes with cautions, please read page 10. Switching between on / off can be done at anytime. There may be a 10 second delay in unit operation between switches - no need to reset / reconnect the BB.
13. Temperature sensor connector. Here is where to install the temperature sensor - TEMP1. Connect the terminal end of the temperature sensor to the negative terminal of the output battery. If in a Lead or AGM setting the temperature sensor compensates the voltage being delivered by the charger based on sensor temperature. If in a lithium setting, there is no voltage compensation. In lithium, the charger stop charging if sensor detects 0DegC or lower.
14. For remote control connection - **BBR**



**PRODUCT INFORMATION** PANEL Controls | Battery Type Select

LED panel

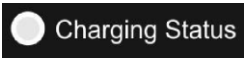
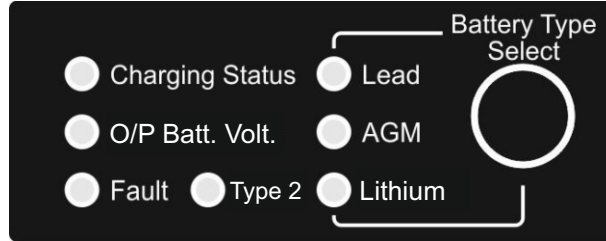

**Lead Acid Charging Profiles**

Orange LED status:

- Fast flashing = Bulk / Fast Charge
- Slow flashing = Absorption
- Solid = Float

**Lithium Charging Profiles**

Orange LED status:

- Fast flashing = Bulk / Fast Charge
- Slow flashing = Absorption

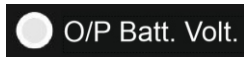

Orange LED status:

- Fast flashing = Low battery voltage, battery needs a good charge
- Slow flashing = Medium battery voltage, mid charge.
- Solid = Good battery voltage, nearer charge completion.

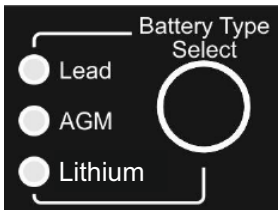

**Battery Type Select**

When charger is on, press and hold the Select button for 5 seconds until the LEDs flash. Then, press the Select button to toggle through the 6 different battery types - the flashing orange LED shall depict the battery type. Type 2 LED shall light up to display the second profiles of the battery types. Once you have the LED on the battery type you, want wait until the LED stops flashing - after a few seconds the flashing stops and the LED stays on solid - this confirms setting.









**Absorption time lengths:**

As the BB can measure both current and voltage it shall make an intelligent decision as to when to transfer from absorption to float mode. This algorithm detects both the rate of rise of voltage and the rate of decline of current. If the target absorption voltage has been met and the current has dropped to a few amps the charger shall transfer to float mode.

**Float to absorption trigger voltages.** If the charger is in float and the output batteries voltage is dragged below the following voltages the charger shall go back to absorption.

- Lead I = 12.6V
- Lead II = 12.7V
- AGM I = 12.4V
- AGM II = 12.8V
- Lithium I = 13.4V
- Lithium II = 13.2V

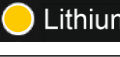

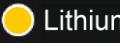
LED sequence	Battery Type	Absorptions (V)	Float (V)
 Lead	Lead I	14.4V	13.3V
 +  Lead	Lead II	14.6V	13.5V
 AGM	AGM I	14.2V	13.1V
 +  AGM	AGM II	14.7V	13.6V
 Lithium	Lithium I*	14.4V	13.8V
 +  Lithium	Lithium II*	14.2V	13.6V

Lithium\* = live output voltage, ideal for waking up BMSs on batteries. Please ensure your lithium battery has an internal or external BMS. If you want a float voltage please use Lead or AGM profiles. If temperature sensor connected, no voltage compensation on lithium profiles. If temperature sensor detects 0 Deg C - BB stops charging.

Description of faults on page 11

**PRODUCT INFORMATION**

**Charge control modes - how to get the BB1270 to turn on and begin charging**

**Automatic Mode (Default)**

This mode is the simplest way to install the BB1270, however, not the most effective if you are using this BB on a modern vehicle that has regenerative braking (Euro 6 engine or newer).

To activate the BB, you require 13.5V+ on the input terminal. You shall achieve this voltage by charging up your input battery (starter battery) with an alternator (for example).

When the input voltage drops below 12.8V (when you turn your engine off), the BB shall turn off and go to sleep.

**Input voltage**

Charger on - 13.5 -> 16V

Charger off - <12.8V

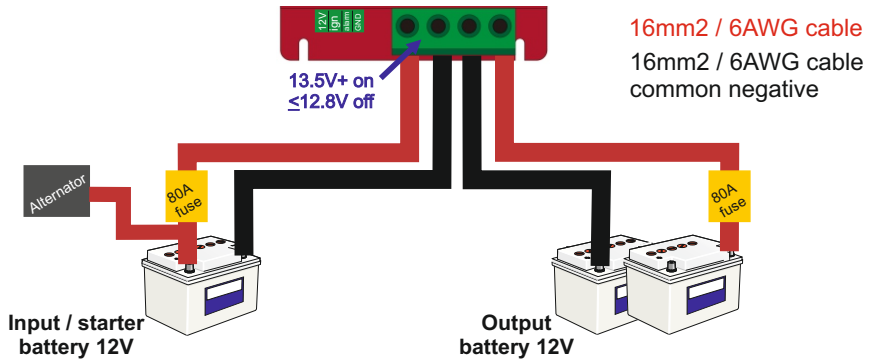

**EURO 6**

**Ignition feed Mode (requires 12V signal feed)**

In this mode you control the BB based on an ignition signal. Essentially when you are running your engine the signal is ~12V and BB works. When you turn your engine off - signal turns to 0V - the BB turns off.

The BB also requires 11.0V+ on the input battery. If starter battery is lower than this w/ live ignition, BB will not work.

**WARNING**, if ignition is live, but engine not running, **flat starter battery!**

**Input voltage + ign feed.**

Charger on - 11V -> 16V

Charger off - <10V

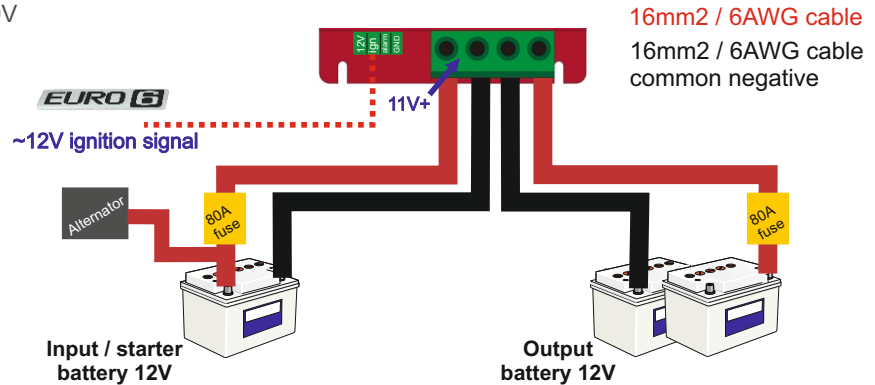

By applying a live signal to the ignition connector you put the BB into ignition dependent mode. The BB shall NOT work unless it has a live ignition signal - even if you remove the ignition feed cable and provide 13.5V+ onto the input terminal.

To reset the BB back to Automatic Mode, ensure BB is on -

- I) Remove ignition cable from ign connector.
- II) Press and hold SETUP button for around 15 seconds until the 3 LED battery types flash at the same time.
- III) Release button and charger reverts to Automatic Mode.

**EURO 6**

**Vibration sense Switch position ON.**

This mode requires the BB to detect 2 vibration events in order for it to turn on and charge. For example, turning an engine on shall provide sufficient vibration to get the BB to begin charging.

This mode essentially acts like an ignition signal and is designed for installers to do away with having to run an ignition feed.

**WARNING**, if vibration signal activates BB, shall drag starter battery voltage to below 11V. Possible flat starter battery! The BB does monitor the input battery and shall turn off after 2 minutes if the voltage does not climb up.

**Input voltage + vib. sense.**

Charger on - 11V -> 16V

Charger off - <10V

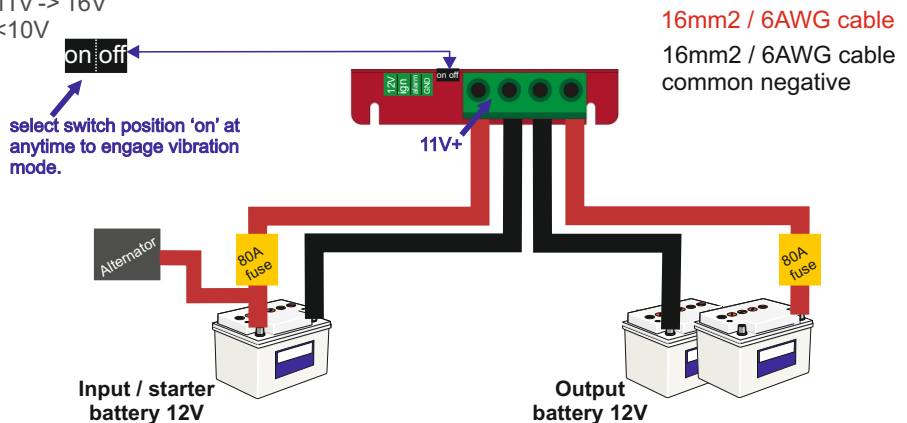



STERLING  
POWER

## Troubleshooting & Faults

Troubleshoot - checks to ensure the BB is installed correctly and receiving the correct input and output voltages.

Firstly, ensure the BB1270 is wired up correctly. Ensure negatives are common and the BB charger's negative is connected to the starter battery's negative - avoid connecting to chassis negative. Voltages between common negatives should be ~0V.

Secondly, to test the BB, remove (or turn off) any secondary charging source like AC to DC battery chargers or solar chargers going to the battery banks. Leave the primary charger connected (alternator) - ensure alternator is working. We also recommend turning off any loads (inverters etc.).

### How to test if the BB is charging:

With engine running (alternator charging), what is the voltage on the input terminal of the BB? What is the voltage on the output terminal of the BB? Measure these voltages at the BB's terminals, not at the batteries terminals.

By default, the BB requires 13.5V+ to turn on and get going. If you are getting alternator voltage at the input terminal (~14V) and 14V+ on the output terminal the chances are your BB is working fine. If little to no current is passing through the charger at these voltages then the batteries are either full or they are duff. If the output voltage is between 13V-14V (but rising) then you could have a situation where the output batteries were very low in charge (or large in capacity) and the charger shall be charging at maximum current. Provided this output voltage continues rising the BB is charging.

### If your output voltage is less than 13V and your input voltage is healthy, it could be three things:

- 1) You have a large load on your output bank - turn load off.
- 2) The BB may have enter a fault state an stopped charging.
- 3) The BB is not working / failed.

### If your input voltage is less than 13V, it could be several things:

*Automotive:* Your alternator's voltage is at less than 13V (the alt. is in regenerative braking mode - sometimes expected on modern Euro 5/6+ engines) - take vehicle for drive and measure alternator's voltage and set up the BB to suit these needs. All vehicle manufactures have their own software / characteristics for regen. braking. Resort to running ignition signal to BB to ensure BB operates irrespective to fluctuating input voltage.

*Automotive or Marine:* If your alternator's voltage is ~14V then check continuity between the alternator's B+ terminal and the starter battery. If you are getting ~14V on starter battery then check continuity between starter battery and BB input terminal.

*Automotive or Marine:* If your alternator's voltage is 0-13V (starter battery voltage) then alternator may have failed. Or, requires increase rpm of engine, possible belt slip.

### Is your output voltage slightly higher or lower than expected - even with no loads / chargers on?

Check if you have the temperature sensor connected. If so, no problems leaving it there, it is simply voltage compensating for when the temperature at the sensor is lower or higher than the benchmark 20DegC (69F). If lower, then the voltage shall rise and vice versa. The further from 20DegC in either direction leads to proportional increase or decrease in the voltage.

If the voltage at your output battery is 0.3V lower (or more) than at the output of the BB - this is likely due to poor / thin cabling. And / or, due to voltage drop across fuses / fuse holder / isolation switch / relay / diode etc.. between the output of the BB and your output battery. Beef up the cable, clean connections, ensure connections are as tight as possible, remove unnecessary devices (such as isolation switches, relays or diodes) - these are really not required here.

What output current rates to expect at lower input voltages

input voltage	output A
>13.6V	~60A
12.8V - 13.6V	~55A
<12.8V	~45A



Fault LED - shall come on solid, if a fault is detected.

This LED is red colour.

The fault can be a single fault or multiple faults. There are 6 faults that can be detected - all of which are mentioned in this table.

Problem	Possible Cause	Suggested solution	Recovery Condition
Low Voltage Disconnect (LVD) on input - in Auto Mode	input voltage is lower than 12.8V or no ignition signal is detected.	Turn engine on   ensure cable thickness between input and starter battery is sufficient.	The fault shall clear automatically when input voltage rises above 13.5V.
Low Voltage Disconnect (LVD) on input - in Ignition / Vibration Mode	input voltage is lower than 10V and/or no ignition signal is detected.	Turn engine on   ensure cable thickness between input and starter battery is sufficient. ~12V at ignition	The fault shall clear automatically when input voltage rises above 11V + live ignition / vibration signal
Output Over Voltage Protection (output OVP)	output voltage has exceeded 0.6V+ on top of set absorption voltage.	check loads or chargers on output battery. C heck where high V is coming from	When output voltage drops below 0.3V on top of set absorption voltage the BB resumes charge.
Input Over Voltage Protection (input OVP)	input voltage has exceeded 16V.	likely alternator voltage has gone too high. If Euro 6 vehicle - this is okay, BB shall reboot when V drops.	When voltage drops below 15.5V the BB shall turn on and resume charging after 30 seconds.
Over Temperature Protection (OTP)	Charger's internal temperature is too high	Check input and output exhausts for blockages. 10mm	When charger temperature reduces charging resumes
Fan Fault	Failed fan	objects may be jamming the fan, fan may be old, clogged up.	When fan is operational the fault light turns off.



**Troubleshooting & Faults** If the BB's performance is reduced it could be because of voltages or temperature:

This table shows the performance down rating of the BB when input voltage drops at the input terminals of the BB. If you have a 24V input model, simply double the voltage values.

Criteria	Output Power (% of Rated Current)	Remark
Input voltage less than 12.8V + live ignition	65%	Power reduction due to impotent alternator performance / Euro 6 and/or poor connections
Input voltage less than 13.2V but higher than 12.8V + live ignition	85%	Power reduction due to impotent alternator performance / Euro 6 and/or poor connections
Input voltage 13.5V or higher	100%	Charger performance back to normal.

This table shows the performance down rating of the BB when internal temperatures rise to certain DegC.

- Temperatures could rise due to:
- High ambient temperatures.
  - High continuous working with moderate ambient temperatures.
  - Fan could be impeded, deteriorating or failed.

Criteria	Output Power (% of Rated Current)	Remark
If the temperature sensor in the inductor reaches ~105 DegC+	0%	The charger shall simply stop charging and wait to allow the unit to cool down
If the temperature sensor in the inductor reaches ~100 DegC+	65%	Power reduction due to high internal temperature.
If the temperature sensor in the inductor reaches ~90 Deg C+	85%	Power reduction due to high internal temperature.
If the temperature sensor in the inductor is <75 Deg C	100%	No power reduction.

*These temperature are accurate based on +/- 5DegC*

